

This document is the property of Nian-Yeong Corporation and is delivered on the express condition that it is not to be disclosed, reproduced or used, in whole or in part, for manufacture or sale by anyone other than Nian-Yeong Corporation without its prior consent, and that no right is granted to disclose or to use any information in this document.

CUSTOMER DRAWING

REV.	DESCRIPTION	APPROVED BY	DATE	ECN NO.
A	RELEASE	KU Chou	02/05/18*	
B	ADD PART NO.	Emily Suen	09/07/18*	
C				
D				

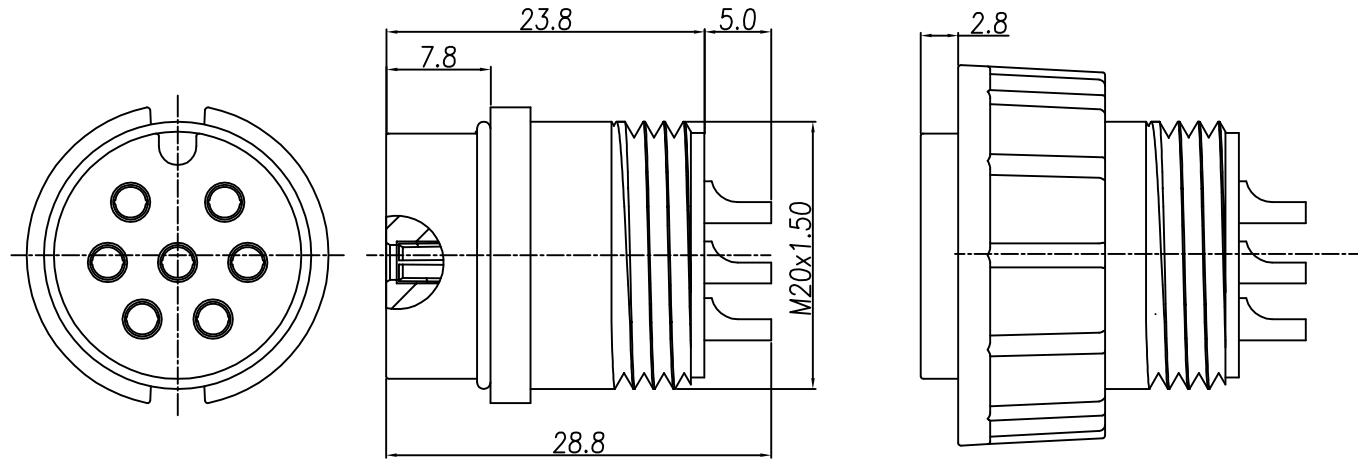

ASS'Y

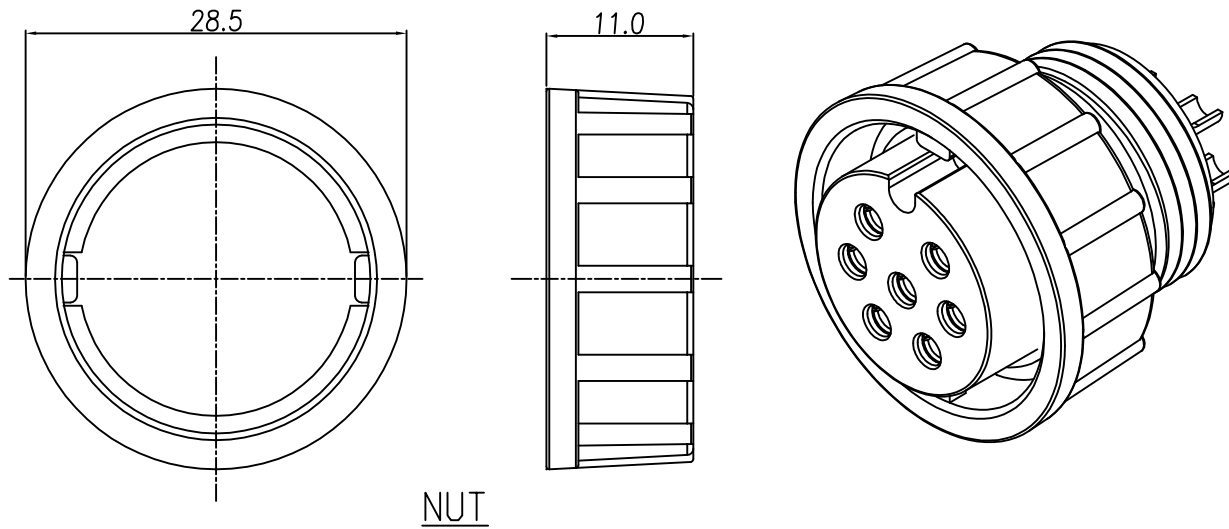

NUT

1. MATERIAL :
 - 1-1. HOUSING : PA66
 - 1-2. CONTACT : BRASS
 - 1-3. O-RING : SILICONE
 - 1-4. NUT : PA66
2. FINISH :
 - 2-1. CONTACT : GOLD FLASH PLATED
3. ELECTRICAL SPECIFICATION :
 - 3-1. Rated current : 20A
 - 3-2. Rated Voltage : 300V
4. Environmental :
 - 4-1. Operation Temperature : -20°C~80°C

DRAWN	Yeh Chou	APP'D	KU Chou	UNIT	mm	TOLERANCE		NIAN YEONG ENTERPRISE 年永實業有限公司	TITLE	D SIZE (FEMALE PIN) 線規-20A			SHEET
CHK'D	KU Chou			SCALE	1:1	.x ±0.20 .xx ±0.10 .xxx ±0.05 .xxxx ±0.03 ANGULA ±1°			PART NO.	SEE TABLE A	DWG NO.	QC8384	1 2 VERSION B

This document is the property of Nian-Yeong Corporation and is delivered on the express condition that it is not to be disclosed, reproduced or used, in whole or in part, for manufacture or sale by anyone other than Nian-Yeong Corporation without its prior consent, and that no right is granted to disclose or to use any information in this document.

CUSTOMER DRAWING

REV.	DESCRIPTION	APPROVED BY	DATE	ECN NO.
A	RELEASE	KU Chou	02/05/18*	
B	ADD PART NO.	Emily Suen	09/07/18*	
C				
D				

TABLE A

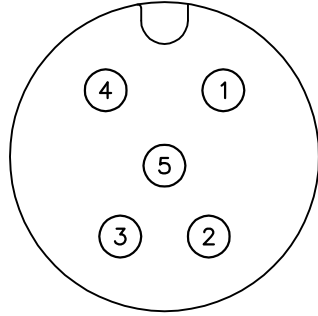

5P

WP-05F2-148-11

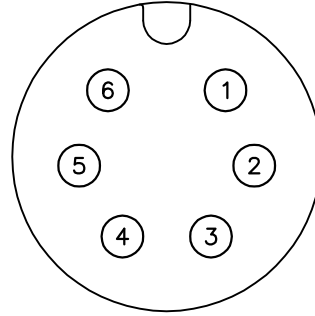

6P

WP-06F2-76-11

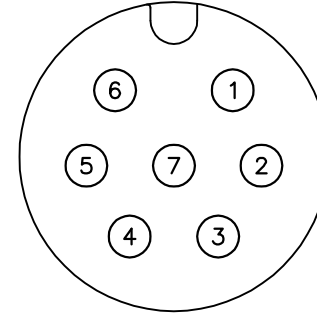

7P

WP-07F2-07-11

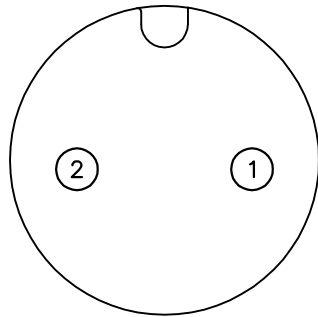

2P

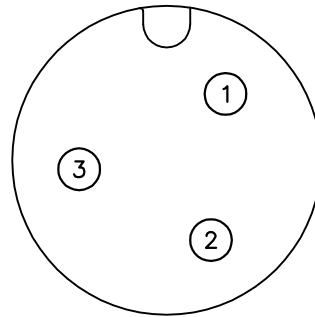

3P

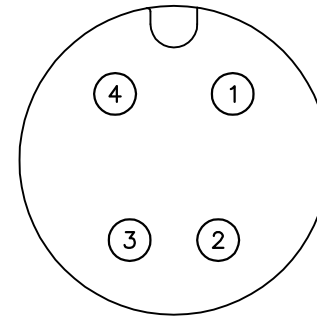

4P

WP-04F2-205-11

PIN CONFIGURATION

DRAWN	Yeh Chou	APP'D	KU Chou	UNIT	mm	TOLERANCE				TITLE	D SIZE (FEMALE PIN) 線規-20A			SHEET
CHK'D	KU Chou			SCALE	1:1	.x ±0.20 .xx ±0.10 .xxx ±0.05 .xxxx ±0.03 ANGULA ±1°				PART NO.	SEE TABLE A	DWG NO.	QC8384	2/2
NIAN YEONG ENTERPRISE 年永實業有限公司													VERSION	
													B	