

This document is the property of Nian-Yeong Corporation and is delivered on the express condition that it is not to be disclosed, reproduced or used, in whole or in part, for manufacture or sale by anyone other than Nian-Yeong Corporation without its prior consent, and that no right is granted to disclose or to use any information in this document.

CUSTOMER DRAWING

REV.	DESCRIPTION	APPVL. BY	DATE	ECN NO.
A	RELEASE	Emily Suen	10/07/12"	
B				
C				

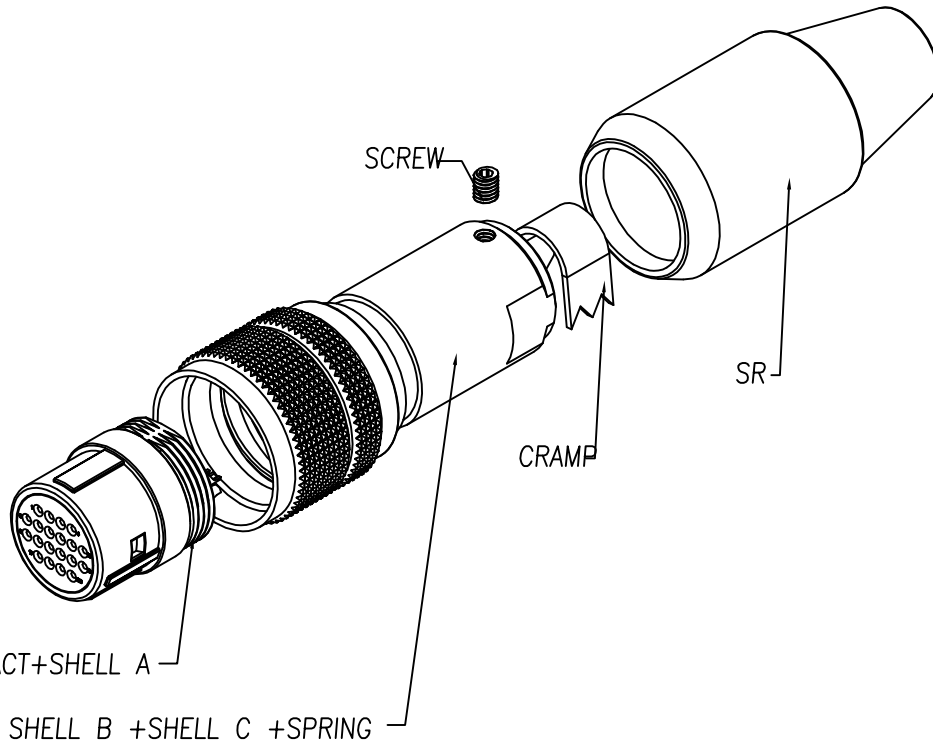
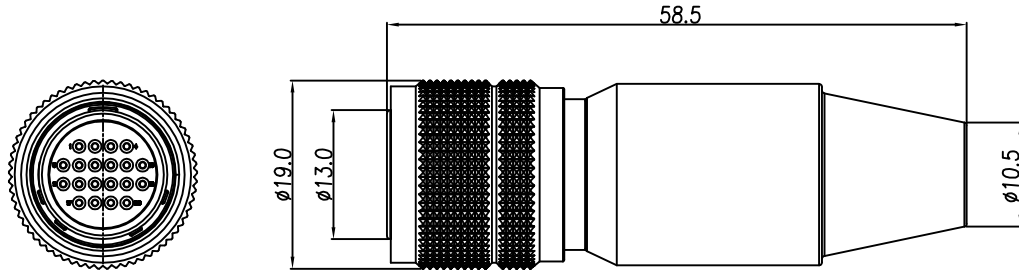

1. MATERIAL :

- 1-1. HOUSING : NYLON46 UL94V-0 ; COLOR : BLACK
- 1-2. CONTACT : BRASS
- 1-3. SHELL A : ZINC ALLOY
- 1-4. SHELL B : BRASS
- 1-5. SHELL C : BRASS
- 1-6. SPRING : STAINLESS STEEL
- 1-7. SCREW : ALLOY STEEL
- 1-8. CRAMP : BRASS
- 1-9. SR : NBR ; COLOR : BLACK

2. FINISH :

- 2-1. CONTACT : GOLD FLASH
- 2-2. SHELL A : NICKEL
- 2-3. SHELL B : SATIN NICKEL
- 2-4. SHELL C : NICKEL
- 2-5. SPRING : NICKEL
- 2-6. SCREW : NICKEL

3. ELECTRICAL SPECIFICATION :

- 3-1. Rated current : 2A
- 3-2. Rated voltage : 100V AC / 140V DC

4. Environmental :

- 4-1. Operation Temperature : -25°C~85°C

DRAW	Lai Angus	APPVL	Emily Suen	UNIT	mm	TOLERANCE			TITLE	DIN 20PIN(F) PLUG 20PIN(F) (SHELL SIZE 13mm)			SHEET	1
CHECK	Emily Suen			SCALE	1:1	.x ±0.20 .xx ±0.15 .xxx ±0.05 .xxxx ±0.03 ANGULA ±1°			PART NO.	DI-20F2-01	DWG NO.	QC5834	VERSION	A

NIAN YEONG ENTERPRISE
年永實業有限公司

This document is the property of Nian-Yeong Corporation and is delivered on the express condition that it is not to be disclosed, reproduced or used, in whole or in part, for manufacture or sale by anyone other than Nian-Yeong Corporation without its prior consent, and that no right is granted to disclose or to use any information in this document.

CUSTOMER DRAWING

REV.	DESCRIPTION	APPVL. BY	DATE	ECN NO.
A	RELEASE	Emily Suen	10/07/12"	
B				
C				

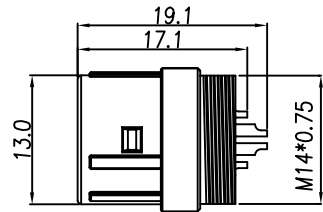
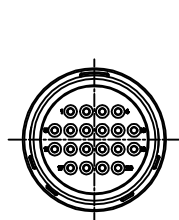

HOUSING+CONTACT+SHELL A

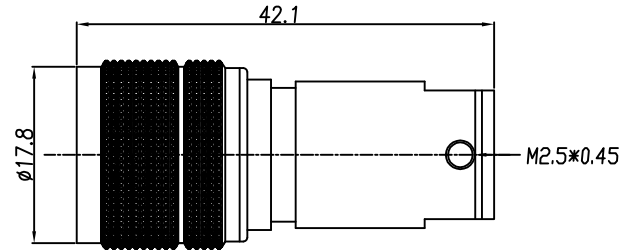

SHELL A +SHELL B +SPRING

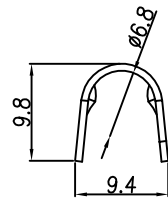
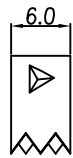
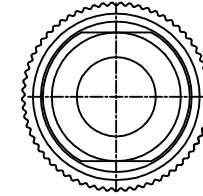

CLAMP

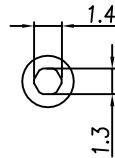
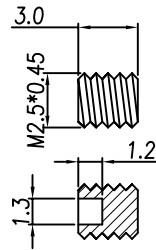

SCREW

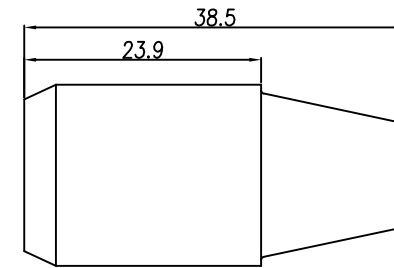
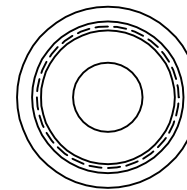

SR

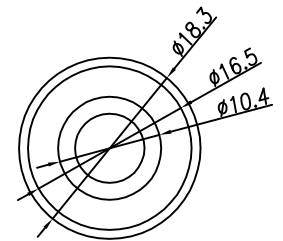

DRAW	Lai Angus	APPVL	Emily Suen	UNIT	mm	TOLERANCE	 	 NIAN YEONG ENTERPRISE 年永實業有限公司	TITLE	DIN 20PIN(F) PLUG 插頭式(SHELL SIZE 13mm)			SHEET	2/2
CHECK	Emily Suen			SCALE	1:1	.xx ±0.20 .xxx ±0.15 .xxx ±0.05 .xxxx ±0.03 ANGULA ±1°			PART NO.	DI-20F2-01	DWG NO.	QC5834	VERSION	A