

This document is the property of Nian-Yeong Corporation and is delivered on the express condition that it is not to be disclosed, reproduced or used, in whole or in part, for manufacture or sale by anyone other than Nian-Yeong Corporation without its prior consent, and that no right is granted to disclose or to use any information in this document.

CUSTOMER DRAWING

REV.	DESCRIPTION	APPROVED BY	DATE	ECN NO.
B	RELEASE	Fido Weng	22/12/08*	
C	修正線型		22/12/08*	ECN15013
D				

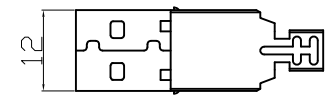
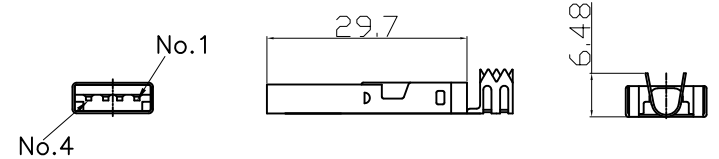
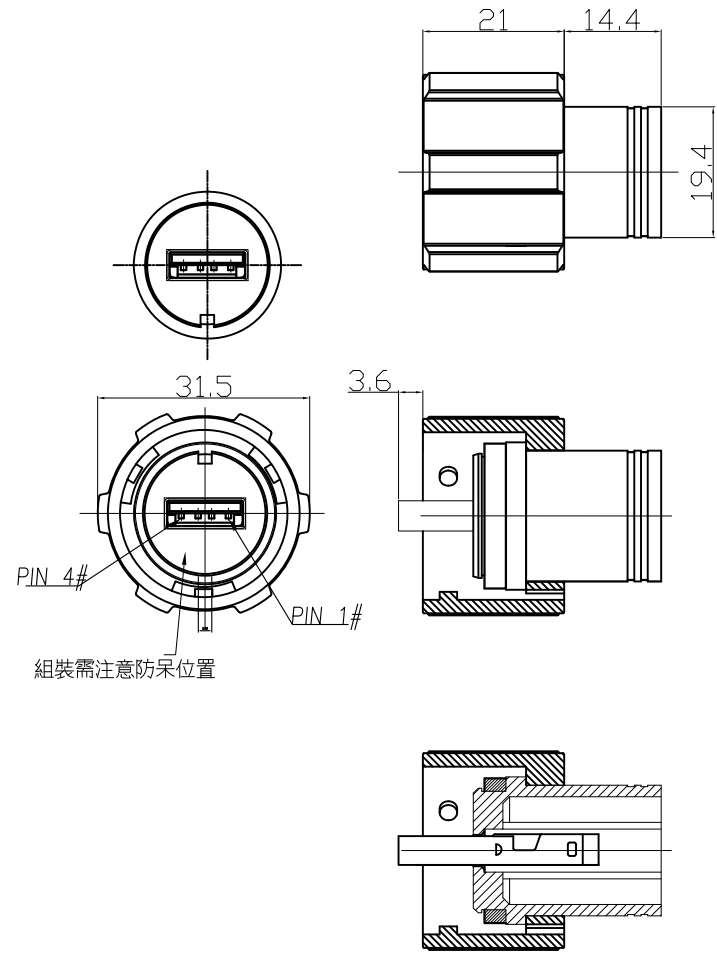

USB 4P (M)

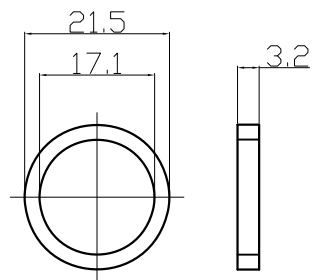

扁型 O-RING(17.1*2.2*3.2)

- MATERIAL :
 - 1-1. EXTERNAL HOUSING : PBT UL94V-0 ; COLOR : BLACK
 - 1-2. EXTERNAL NUT : PBT UL94V-0 ; COLOR : BLACK
 - 1-3. O-RING : SILICONE ; COLOR : BROWN.
 - 1-4. USB :
 - 1-4-1. HOUSING : PBT UL94V-0 ; COLOR : WHITE.
 - 1-4-2. CONTACT : BRASS
 - 1-4-3. SHELL : SPTe
- FINISH :
 - 2-1. CONTACT : GOLD 3u" ON CONTACT AREA
SOLDER TAILS: TIN 100u"
UNDER PLATE : NICKEL
 - 2-2. SHELL: NICKEL ON OVER ALL
- ELECTRICAL SPECIFICATION:
 - 3-1. RATED CURRENT : 1.5A
 - 3-2. RATED VOLTAGE : 30V
 - 3-3. WATER PROOF : IP67
- ENVIRONMENTAL:
 - 4-1. DURABILITY:1500 CYCLES
MATE FORCE:35N (3.57kgf) MAX
UNMATE FORCE:10 N min. initial
 - 4-2. OPERATION TEMPERATURE : -20℃~85℃

防水USB(M) 成品(BLACK)A TYPE

DRAWN	Ren Liao	APP'D	Emily Suen	UNIT	mm	TOLERANCE	 NIAN YEONG ENTERPRISE 年永實業有限公司	TITLE	防水USB(M)線端			SHEET	1/2
CHK'D	Emily Suen			SCALE	1:1	.x ±0.20 .xx ±0.10 .xxx ±0.05 .xxxx ±0.03 ANGULA ±1°		PART NO.	US-04M1-36	DWG NO.	QC5523	VERSION	B

This document is the property of Nian-Yeong Corporation and is delivered on the express condition that it is not to be disclosed, reproduced or used, in whole or in part, for manufacture or sale by anyone other than Nian-Yeong Corporation without its prior consent, and that no right is granted to disclose or to use any information in this document.

CUSTOMER DRAWING

REV.	DESCRIPTION	APPROVED BY	DATE	ECN NO.
B	RELEASE	Fido Weng	22/12/08*	
C	新增螺絲		22/12/08*	ECN15013
D				

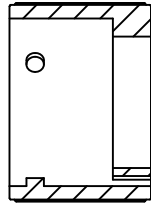
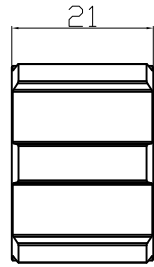
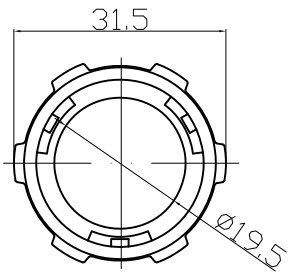

SECTION A-A

防水USB外螺母(黑色)

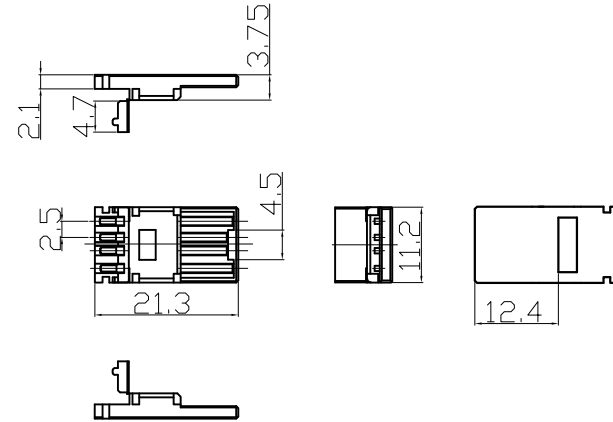

防水頭USB(M)膠芯+PIN

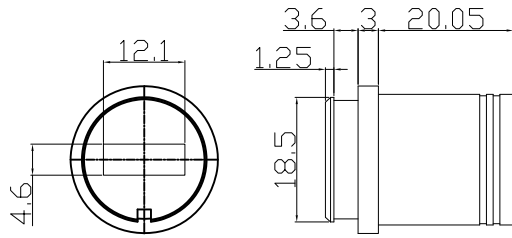

防水頭USB(M)膠芯(黑色)A TYPE

DRAWN	Ren Liao	APP'D	Emily Suen	UNIT	mm	TOLERANCE .x ±0.20 .xx ±0.10 .xxx ±0.05 .xxxx ±0.03 ANGULA ±1°		TITLE	防水USB(M)線端		SHEET	2/2
CHK'D	Emily Suen			SCALE	1:1			NIAN YEONG ENTERPRISE	PART NO.	US-04M1-36	DWG NO.	QC5523

NIAN YEONG ENTERPRISE
年永實業有限公司