

This document is the property of Nian-Yeong Corporation and is delivered on the express condition that it is not to be disclosed, reproduced or used, in whole or in part, for manufacture or sale by anyone other than Nian-Yeong Corporation without its prior consent, and that no right is granted to disclose or to use any information in this document.

CUSTOMER DRAWING

REV.	DESCRIPTION	APPROVED BY	DATE	ECN NO.
A	RELEASE	Fido Weng		
B				
C				

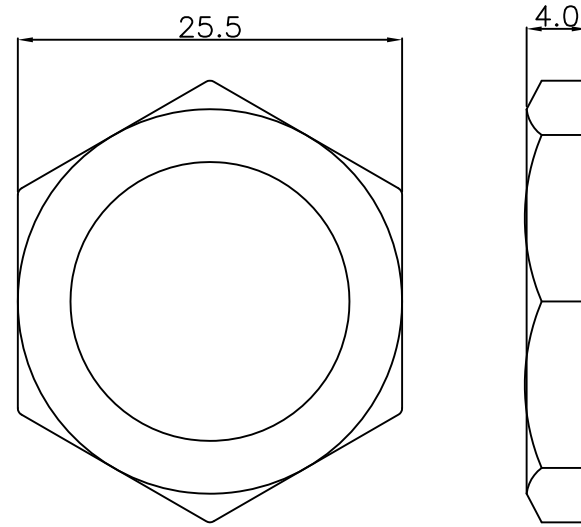
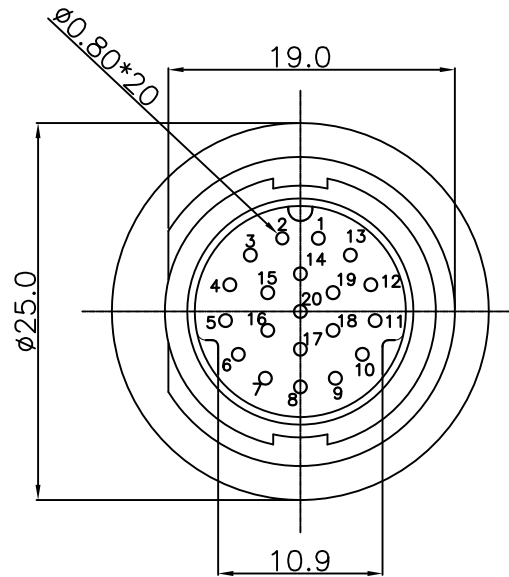
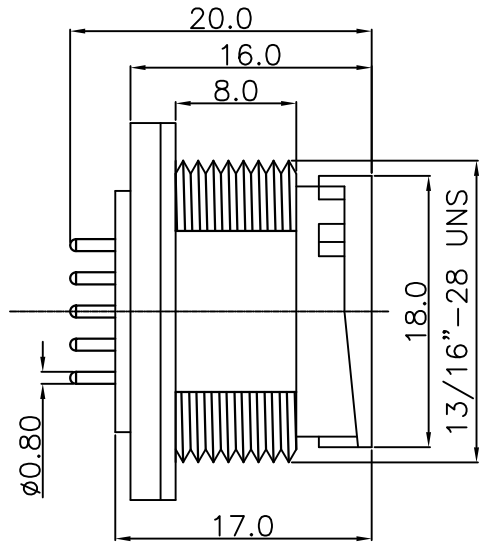

HEX NUT

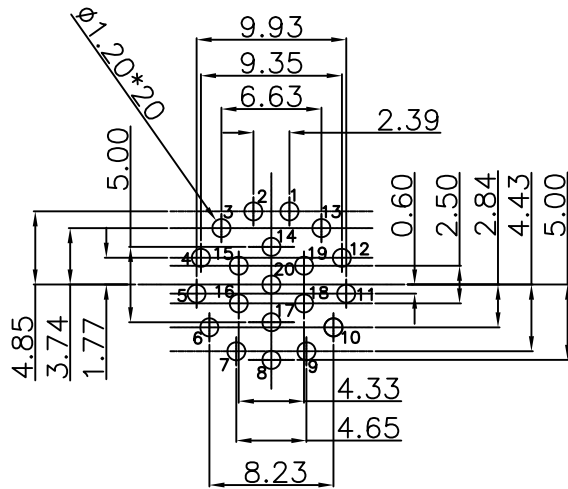

RECOMMEND PCB LAYOUT

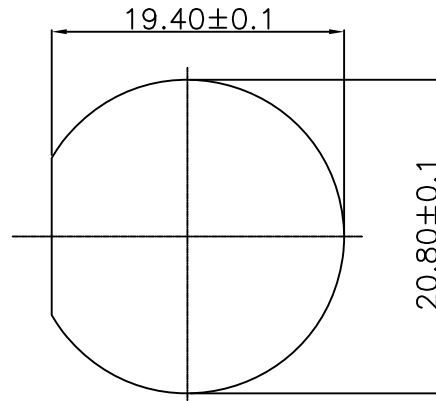

RECOMMEND
PANEL HOLE

- MATERIAL :
 - 1-1. HOUSING : PA66
 - 1-2. CONTACT : BRASS
 - 1-3. GASKET : SILICONE
 - 1-4. HEX NUT : PA66
- FINISH :
 - 2-1. CONTACT : GOLD FLASH PLATED.
- ELECTRICAL SPECIFICATION :
 - 3-1. Rated current : 2A
 - 3-2. Rated voltage : 250V
 - 3-3. Water proof : IP67
- Environmental :
 - 4-1. Operation Temperature : -40℃~105℃

DRAWN	Ku Chou	APP'D	Emily Suen	UNIT	mm	TOLERANCE	NIAN YEONG ENTERPRISE 年永實業有限公司	TITLE	WP 20(M) (LOCK) C-TYPE 板端前鎖DIP式			SHEET
CHK'D	Emily Suen			SCALE	1:1	.x ±0.20 .xx ±0.10 .xxx ±0.05 .xxxx ±0.03 ANGULA ±1°		PART NO.	WP-20M3-01-11	DWG NO.	QC8067	VERSION